

ERF4048, GPS + GSM antenna, SMA Male connector(2x)

Features

Electrical Properties

Parameter:	Description
Frequency Band:	GPS + GSM
Nominal Impedance:	50 Ω
Polarization:	Linear
V.S.W.R:	< 2.0

Mechanical Properties

Parameter:	Description
Antenna Type:	External Antenna
Mounting Method:	Screw Type
Connector Type:	SMA (Male) (2x)
Cable type:	RG174
Antenna Dimensions:	80 mm ± 0.5
Cable Length:	300 cm ± 1
Antenna Color:	Black
Operating Temperature Range:	-40°C~+85°C
Storage Temperature Range:	-40°C~+85°C



Typical applications

- GPS
- GSM
- UMTS
- 4G/3G/2G

Description

The ERF4048 antenna is a black GPS + GSM antenna with 2 SMA (Male) connectors. 1 for GPS and 1 for GSM. The antenna can be used for applications such as, M2M applications, GPS, GSM ,UMTS , 4G/3G/2G and more.

ERF4048, GPS + GSM antenna, SMA Male connector(2x)

Antenna Properties

GPS

Return Loss

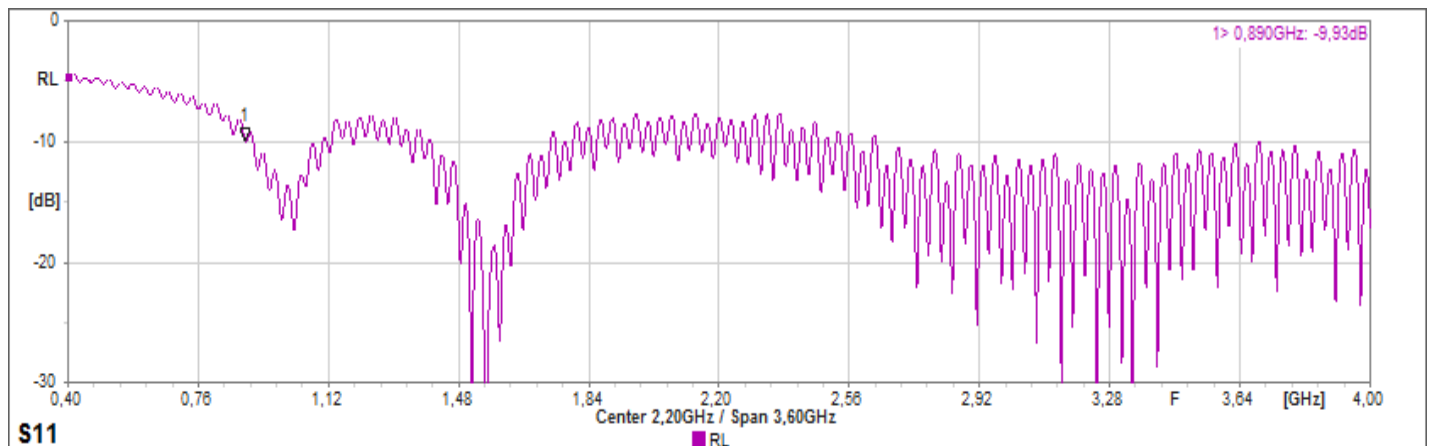

Forward Loss

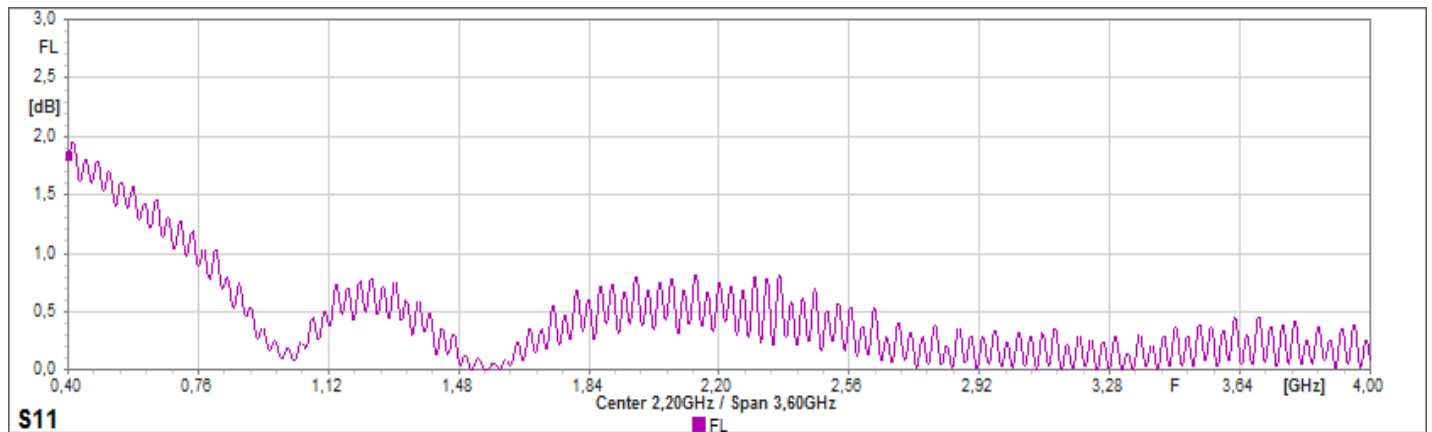

ERF4048, GPS + GSM antenna, SMA Male connector(2x)

Impedance

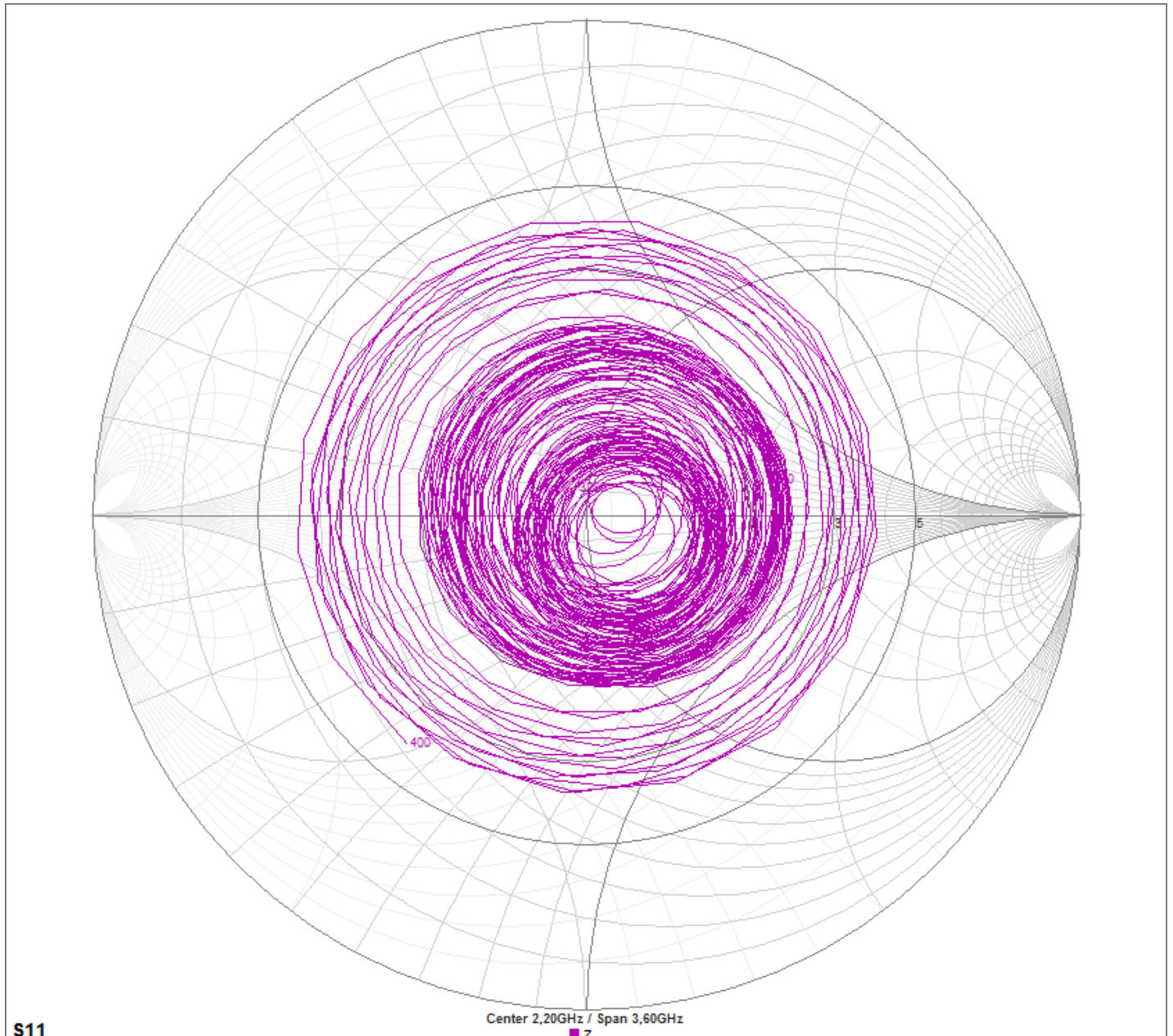

ERF4048, GPS + GSM antenna, SMA Male connector(2x)

GSM

Return Loss

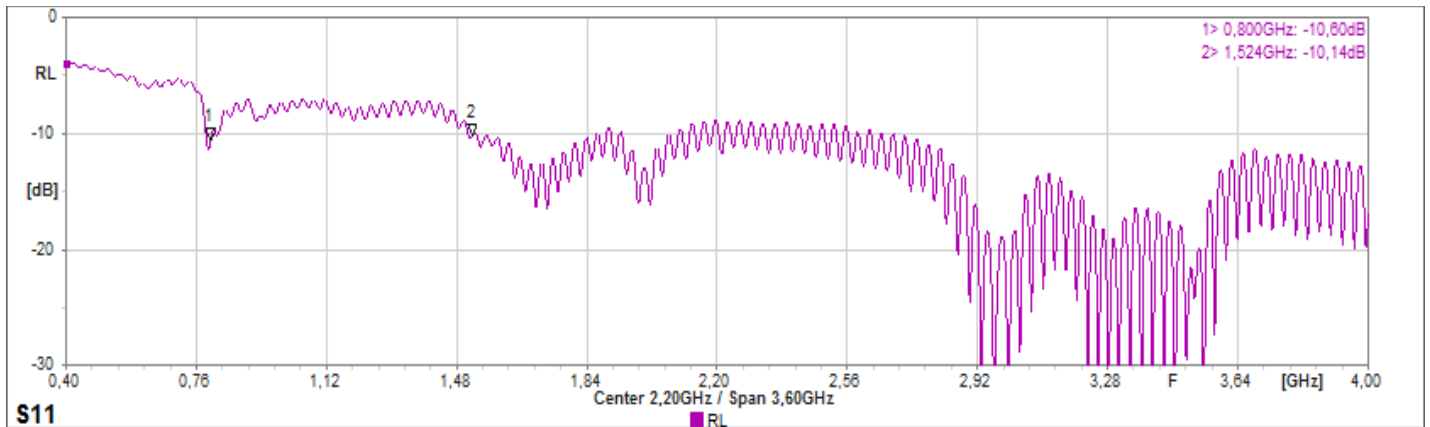

Forward Loss

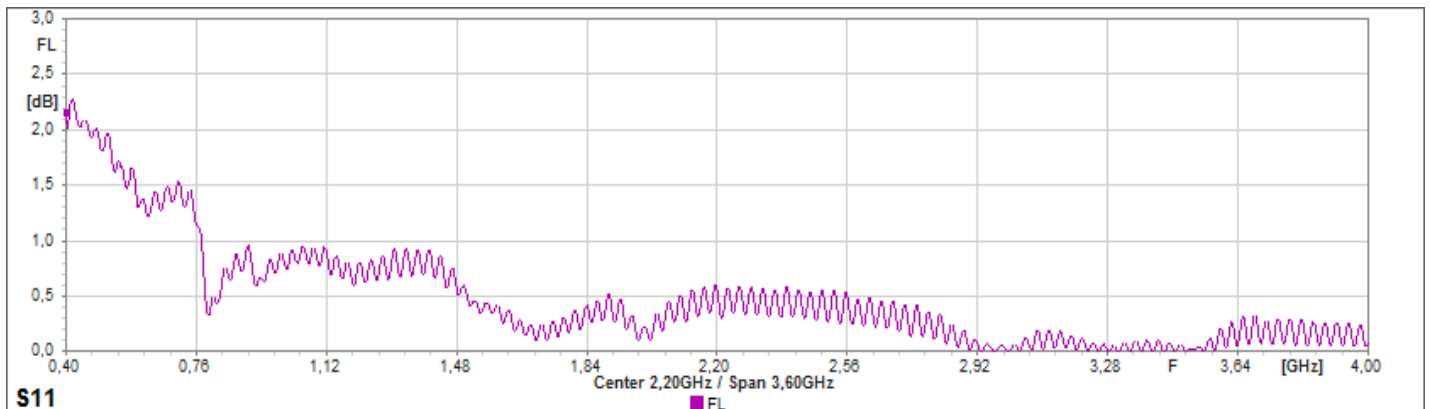

ERF4048, GPS + GSM antenna, SMA Male connector(2x)

Impedance

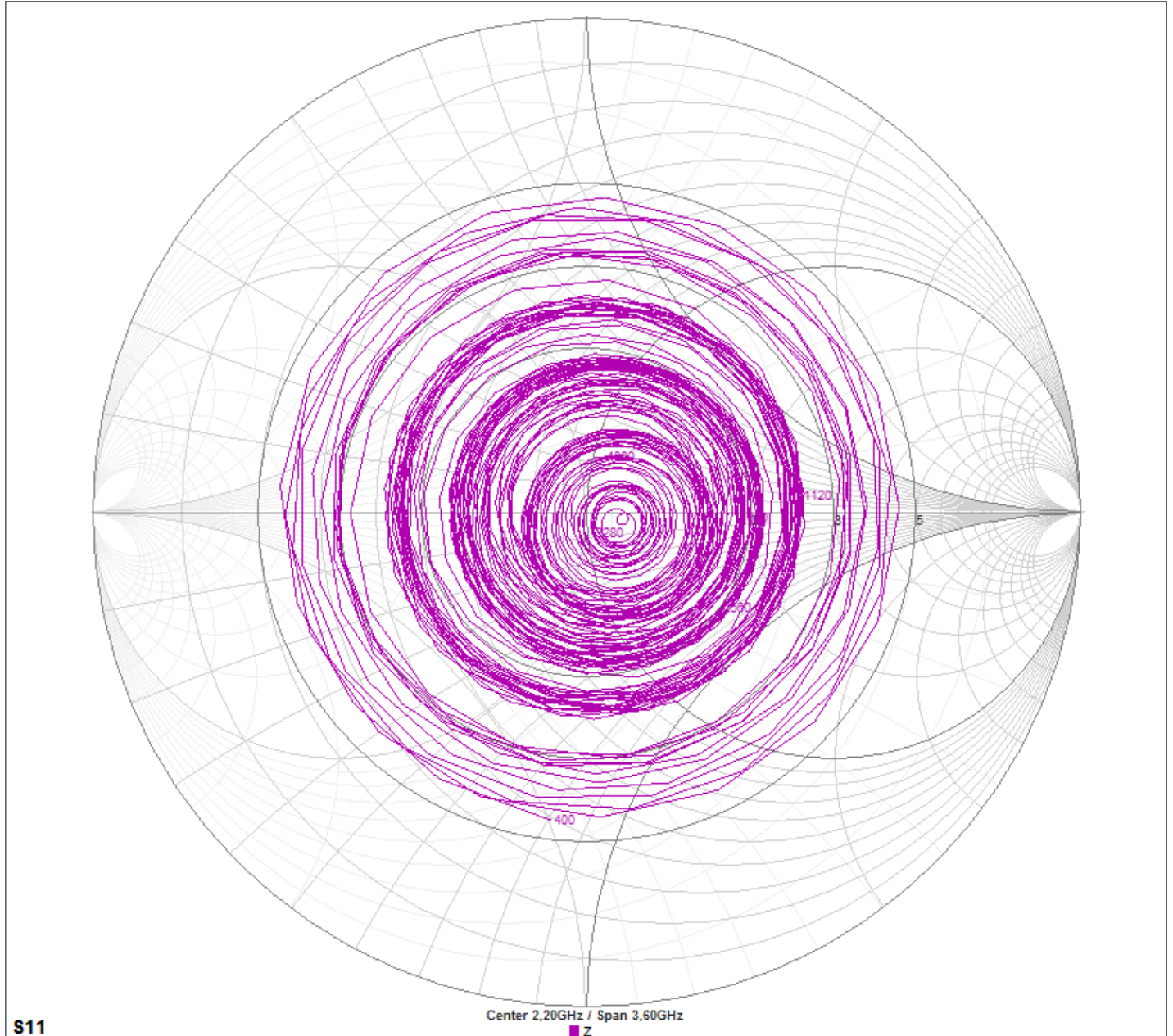

ERF4048, GPS + GSM antenna, SMA Male connector(2x)

Dimensions

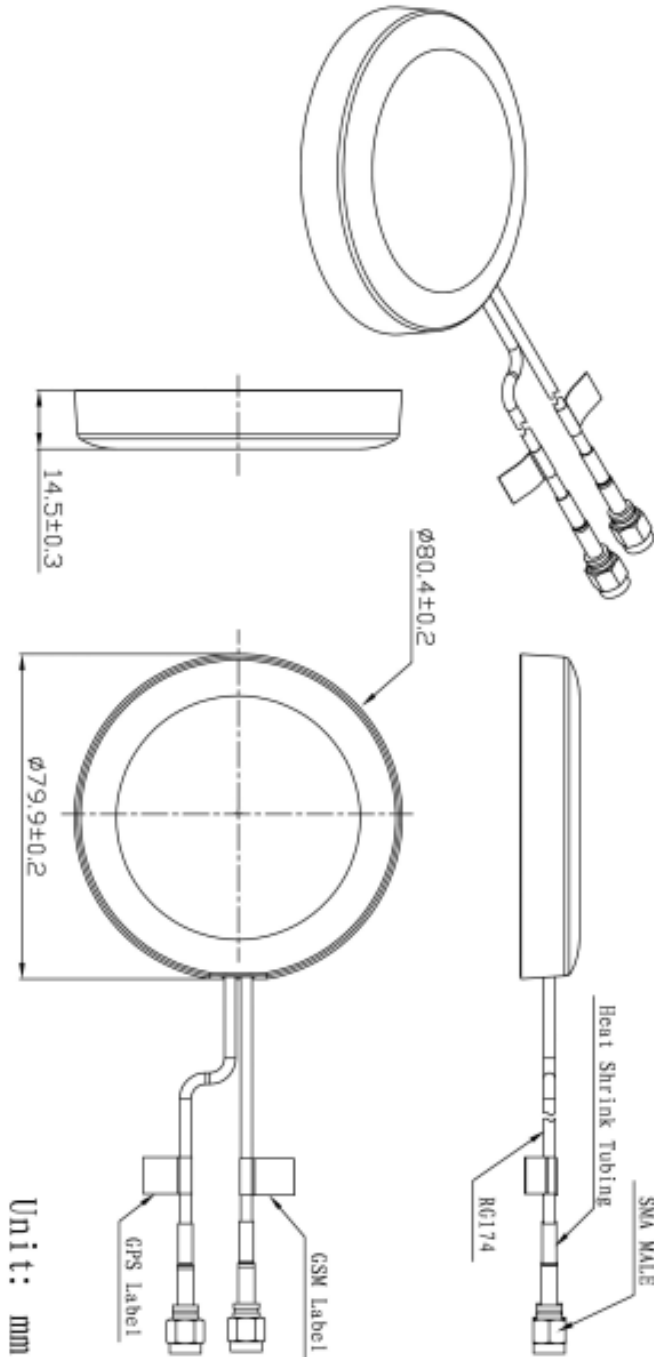

ERF4048, GPS + GSM antenna, SMA Male connector(2x)**Connector****SMA Male****SMA Female****RP-SMA Male****RP-SMA Female**

The ERF4048 antenna uses the SMA male connector (2x).

Ordering information

Ordering can be done via www.summit-electronics.com or via info@summit-electronics.com. Please contact us for more information. Customisation of the product is available on request.

Technical support

For all product questions please contact us via info@summit-electronics.com